

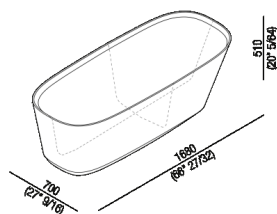

Vasca
 AVAS1095_

Benedini Associati, 2018

Vasca free-standing estremamente leggera e facile da installare.



Vasca in Cristalplant® biobased bianco o bicolore (esterno grigio scuro RAL7021 o grigio chiaro RAL7044); con foro per troppo pieno, senza fori per rubinetteria; questa può essere collocata a parete o a terra. Completa di piletta sifonata con calotta in Cristalplant® bianco .MET0725C (utilizzabile anche per vasche in esposizione). La versione bicolore può essere realizzata con colore indicato dal cliente con maggiorazione del 15% sul costo della finitura bicolore. Per un'installazione più agevole, si suggerisce l'utilizzo del pozzetto per vasca AKITPZVAS.

Finiture

-  Bianco/grigio scuro
-  Bianco/grigio chiaro
-  Bianco

Materiali

-  Cristalplant® biobased

Altezza:	51 cm	20" 5/64 inches
Lunghezza:	169.8 cm	66" 27/32 inches
Peso:	76 kg	168 lbs
Profondità :	70 cm	27" 9/16 inches
Capacità :	300 l	79 gal
Confezione:	100 x 200 x 82 cm	39" 3/8 x 78" 3/4 x 32" 1/4 inches
Peso della confezione:	168 kg	304 lbs



Dimensioni principali

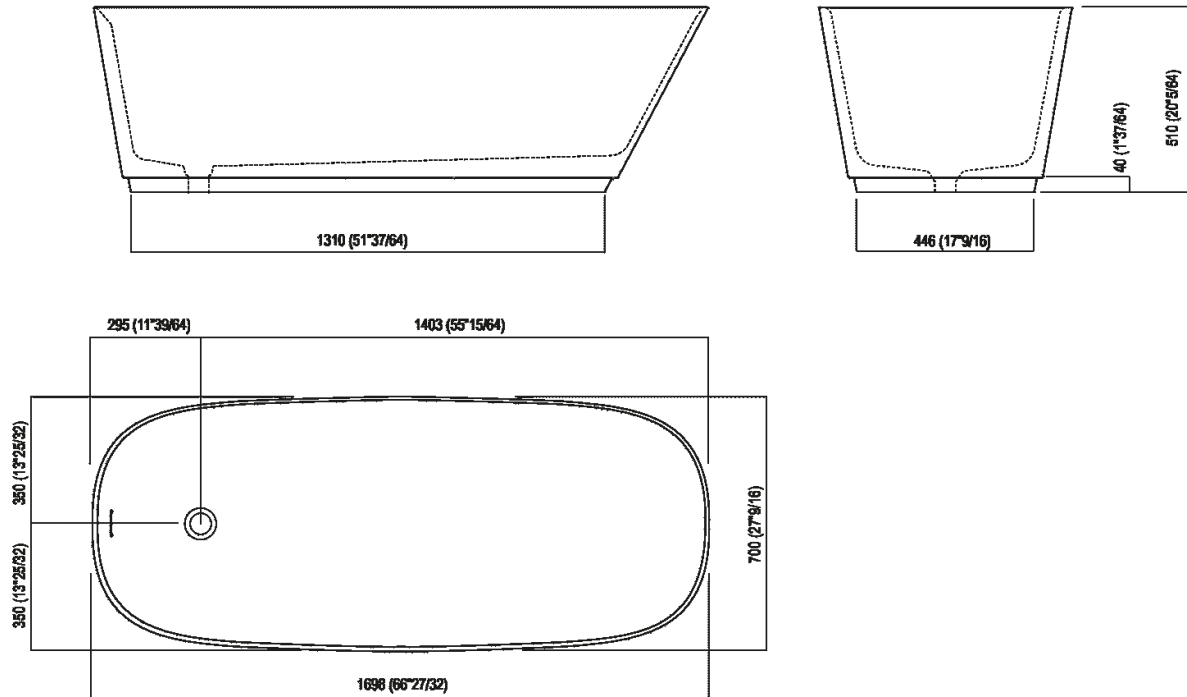



Quote per pozzetto

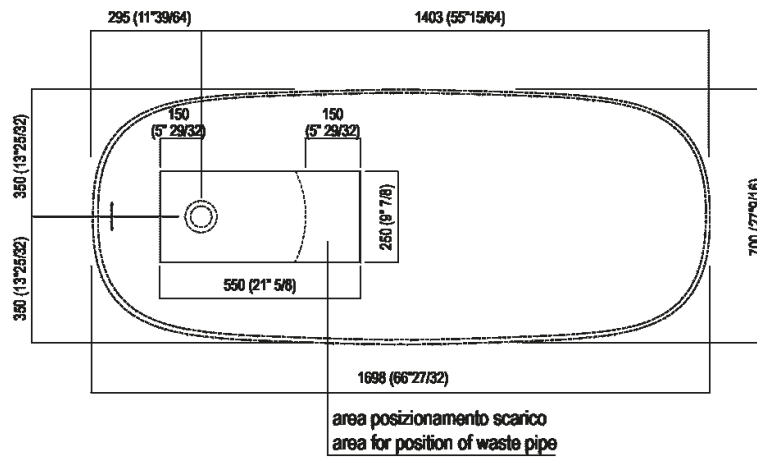



Quote di montaggio: rubinetteria a parete

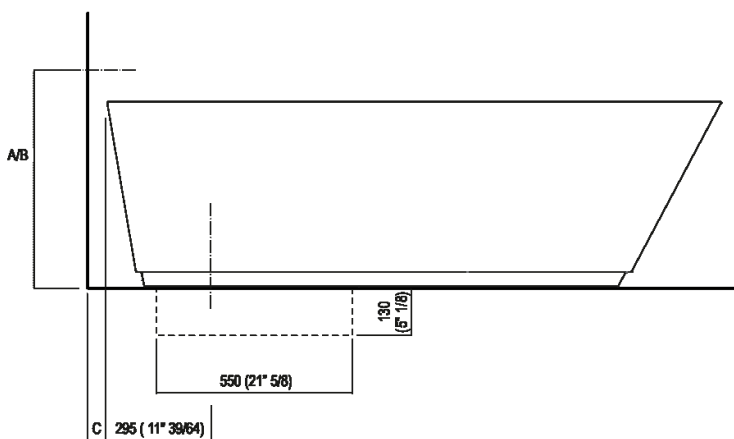
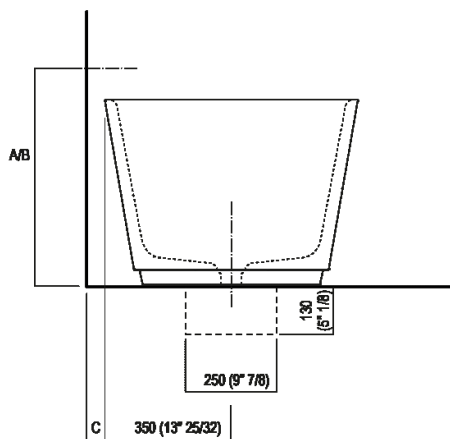

		A*	B**	C
FEZ	ARUB050000L, ARUB051000L, ARUB150000C, ARUB151000C, ARUB190000C, ARUB191000C,	660 (25° 63/64)	-	50 (1°31/32)
MEMORY	ARUB1076, ARUB1077, ARUB1040, ARUB1089, ARUB1091	660 (25° 63/64)		150 (5°29/32)
SQUARE	ARUB0932N, ARUB0933N, ARUB1117	-	640 (25° 13/64)	50 (1°31/32)
SQUARE	ARUB1118	660 (25° 63/64)	-	150 (5°29/32)
SEN	ASEN0912V	-	660 (25°63/64)	50 (1°31/32)

* interasse gruppo / axial distance for tap
 ** filo inferiore gruppo / Tap's lower edge



Quote di montaggio: rubinetteria a pavimento

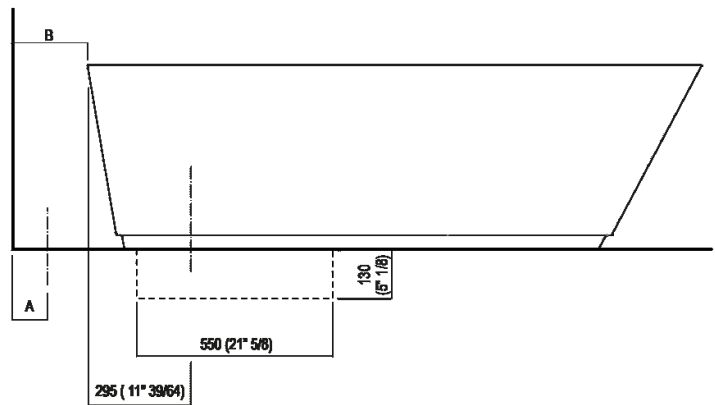
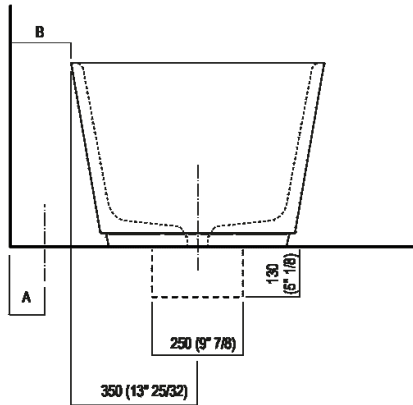

	A	B
SEN (ASEN0911,ASEN0977)	80 (3 ¹ / ₈)	130 (5 ¹ / ₈)
SQUARE (ARUB1112,ARUB1115)	80 (3 ¹ / ₈)	200 (7 ⁷ / ₈)
FEZ (ARUB140,ARUB141,ARUB145,ARUB147,ARUB170)	80 (3 ¹ / ₈)	165 (6 ¹ / ₂)
MEMORY (ARUB1033,ARUB1078)	80 (3 ¹ / ₈)	165 (6 ¹ / ₂)



Note

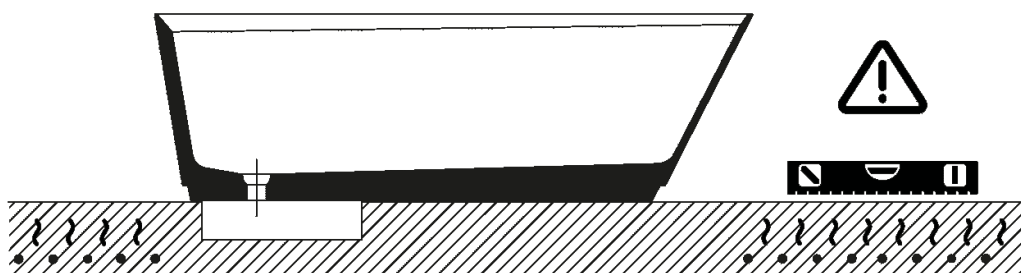

La vasca deve essere installata su un pavimento perfettamente piano.
The bathtub must be positioned on a flat floor surface.

E' necessario predisporre a pavimento un pozzetto.
It is necessary to prepare a recess in the floor.

Evitare di realizzare impianti di riscaldamento nell'area sottostante la vasca.
Avoid the installation of floor heating plants in the area under the bathtub.