

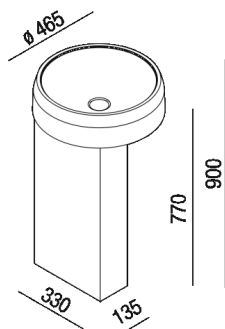

Washbasin support in Cristalplant® biobased for floor drainage with column on the left of the basin
 ACER1073_+ ACER1126FS_

Patricia Urquiola, 2017

Washbasin in Cristalplant®; biobased, Solid Surface or marble.





Washbasin support in Cristalplant® biobased or in marble, wood or wood lacquered open-pore variations; for floor drainage with column on the left of the basin, with (ACER1126FSF_) or without (ACER1126FS0_) holes on the side for the shelf or storage unit. The waste trap (.MET0519) must be installed.

Altezza:	77 cm	30" 5/16 inches
Larghezza:	13.5 cm	5" 5/16 inches
Peso:	16 kg	35 lbs
Profondità :	33 cm	12" 63/64 inches
Confezione:	24 x 43 x 87 cm	9" 27/32 x 16" 59/64 x 34" 1/4 inches
Peso della confezione:	20 kg	44 lbs

Note: The washbasin and the column can be delivered also in Calacatta Vagli and violet Calacatta marble or in stone on demand, price to be calculated. The above measurements refer to the Cristalplant® biobased version, for the marble version the measurements are: Base: 33.5 x 14.5 cm - 12 3/4; 63/64 x 5 5/16; Weight: 31 kg - 68 lbs Packaging: 24 x 43 x 87 cm - 9 27/32 x 16 59/64 x 34 1/4 Gross weight: 41 kg - 90 lbs

Materiali

-  Cristalplant® biobased
-  Marble
-  Wood



Main dimensions

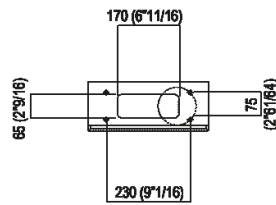
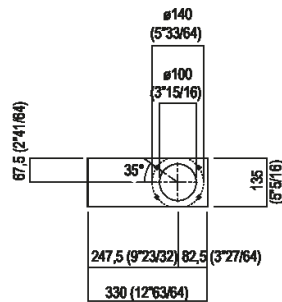
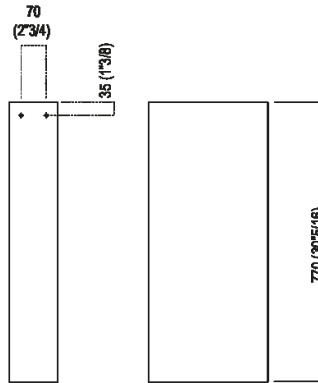



Installation notes: floor-mounted tap

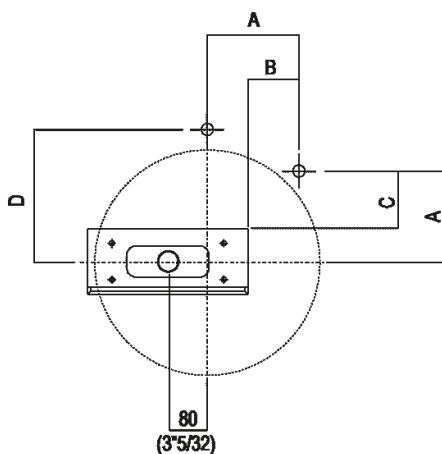
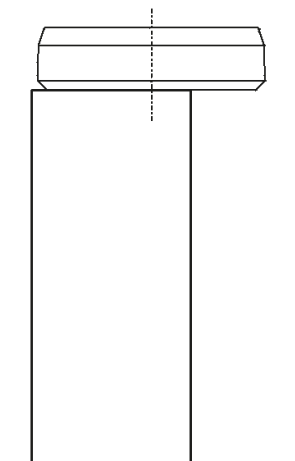

		A	B	C	D
FEZ2	AFEZ004	230 (12*19/32)	148 (5*53/64)	162 (6*3/8)	326 (12*53/64)
	ARUB146	230 (12*19/32)	148 (5*53/64)	162 (6*3/8)	326 (12*53/64)
MEMORY	AMEM323	230 (12*19/32)	148 (5*53/64)	162 (6*3/8)	326 (12*53/64)
	ARUB1092	230 (12*19/32)	148 (5*53/64)	162 (6*3/8)	326 (12*53/64)
SEN	ASEN0962N	190 (10*45/64)	108 (4*1/4)	122 (4*51/64)	268 (10*35/64)
SQUARE	ARUB1096	190 (10*45/64)	108 (4*1/4)	122 (4*51/64)	268 (10*35/64)
	ARUB1020*	190 (10*45/64)	108 (4*1/4)	122 (4*51/64)	268 (10*35/64)

*ad esaurimento / while stocks last