

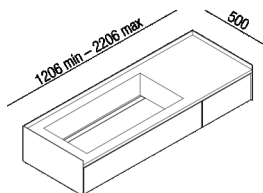







Piano/lavabo con frontale fisso
 ADRP_

Studio MK27, Mariana Ruzante, Marcio
 Kogan, 2018

Piano lavabo autoportante realizzato in
 marmo, incorniciato su tre lati da lastre di
 metallo. Disponibile con diverse lunghezze.



Materiali

-  Legno
-  Marmo
-  Ottone
-  Acciaio inox
-  Cuoio

Piano/lavabo realizzato in marmo bianco di Carrara, grigio carnico, Nero Marquina, verde Alpi o Emperador dark con struttura perimetrale in ottone brunito spazzolato, in ottone naturale spazzolato* o, a richiesta, in acciaio inox satinato. Il lavabo, integrato nel piano, ha lunghezza fissa di cm 80; la profondità ha due dimensioni; quella minore permette di alloggiare la rubinetteria direttamente sul piano. Il frontale sotto al lavabo, con altezza cm 20, è fisso, mentre i laterali sono cassetti dotati di guide ad estrazione totale con apertura push-pull e chiusura soft-closing (portata 40 kg). Le finiture dei frontali possono essere in marmo bianco di Carrara, grigio carnico o nero Marquina, oppure in rovere naturale, bruno, scuro, cenere o in legno precomposto con finitura teak, in cuoio raw, verde o nero oppure in ottone brunito spazzolato, in ottone naturale spazzolato* o, a richiesta, in acciaio inox satinato. La cassa e l'interno dei cassetti hanno la stessa finitura dei frontali quando questi sono in legno; per frontali in marmo, cuoio o metallo è necessario scegliere tra le finiture legno disponibili. Tutti i frontali sono supportati da pannello in MDF laccato grigio scuro. * Su richiesta sono disponibili finiture personalizzate su base ottone naturale.

Altezza:	25 cm	9" 27/32 inches
Profondità :	50 cm	19" 3/4 inches

Note: Disponibile con lunghezze che vanno dai 120 ai 220 cm. Nota: i frontali in marmo verde Alpi e Emperador dark non sono realizzabili.



Dimensioni principali: per rubinetteria a parete

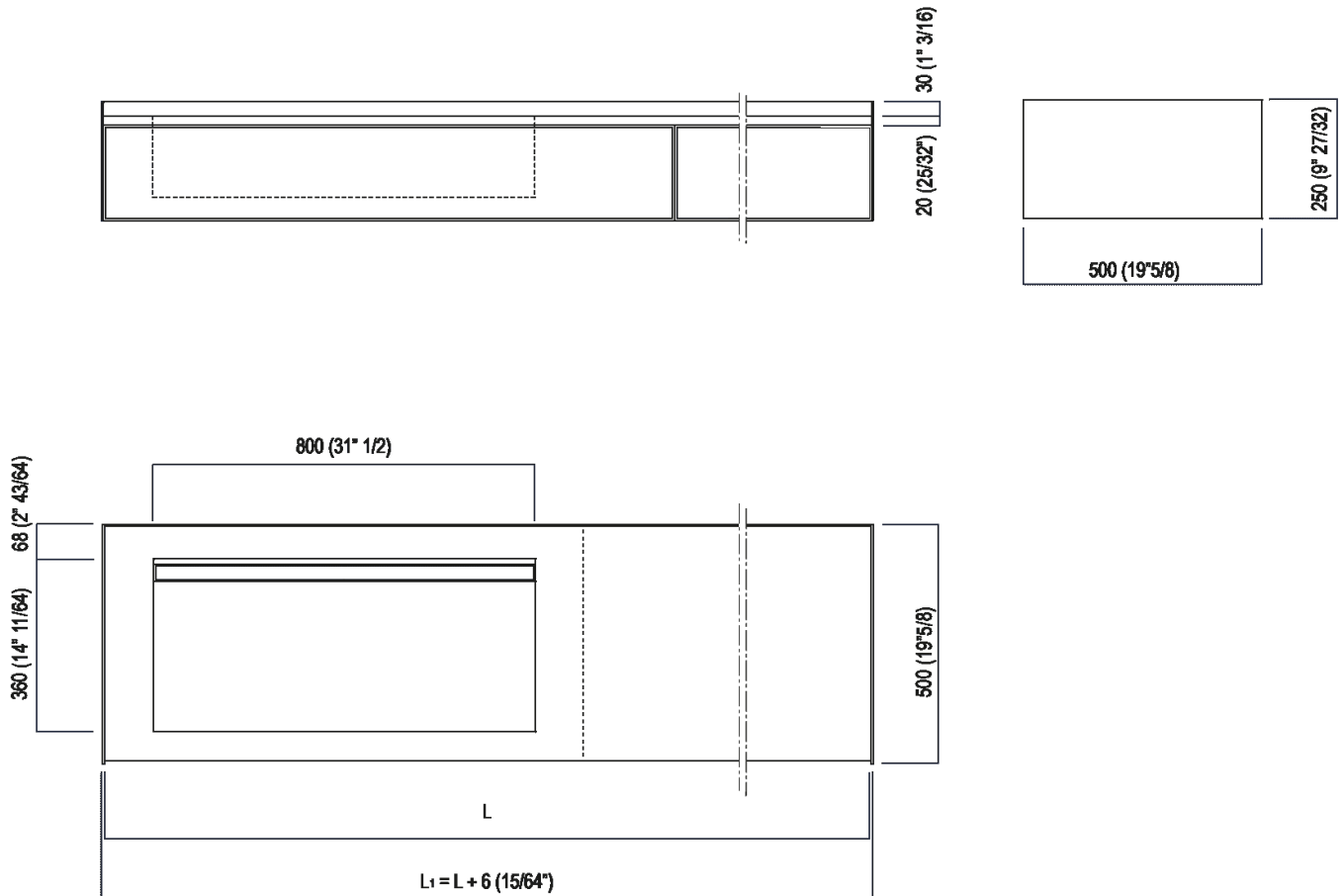



Dimensioni principali: per rubinetteria su piano

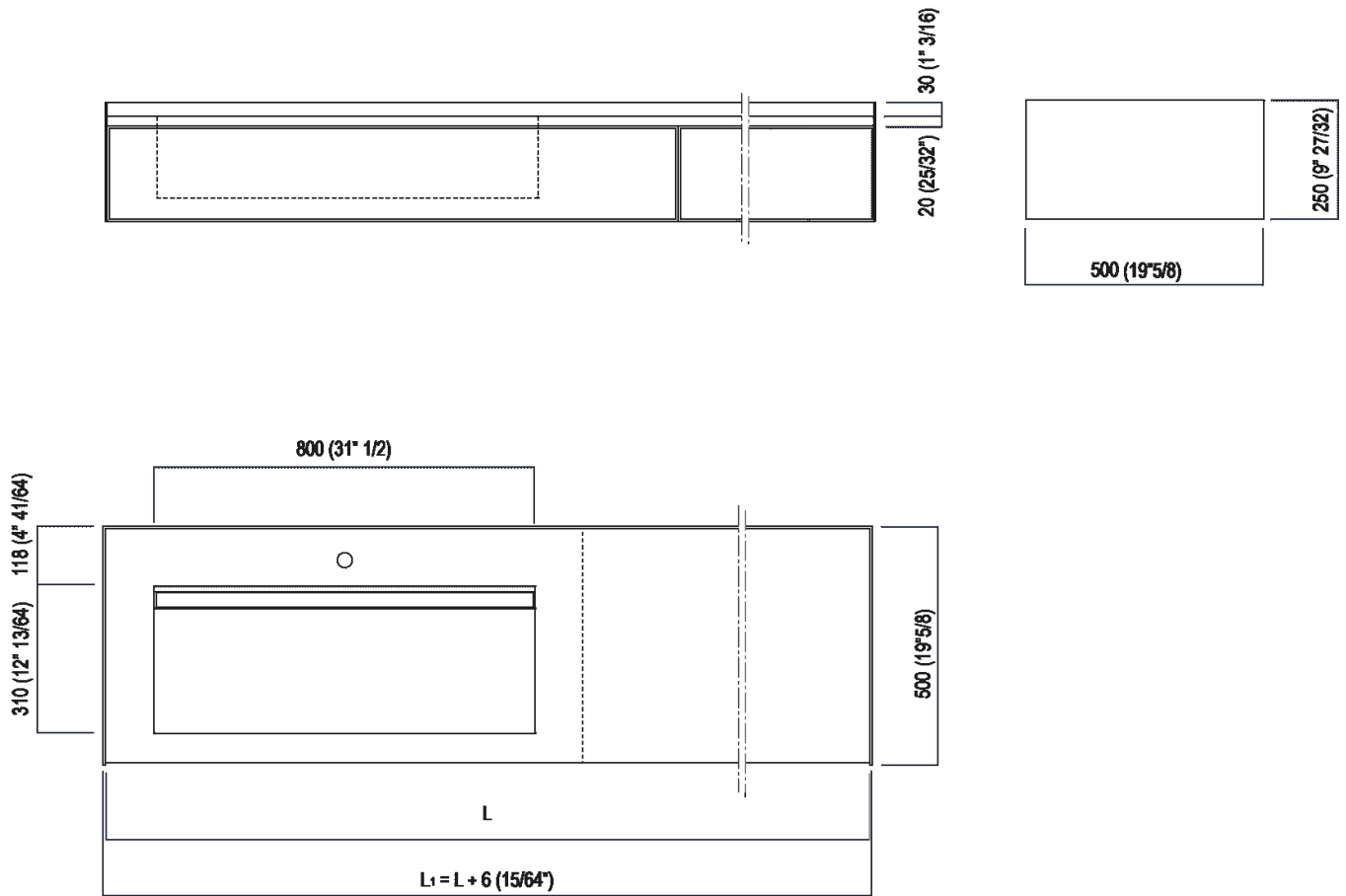



Quote di montaggio

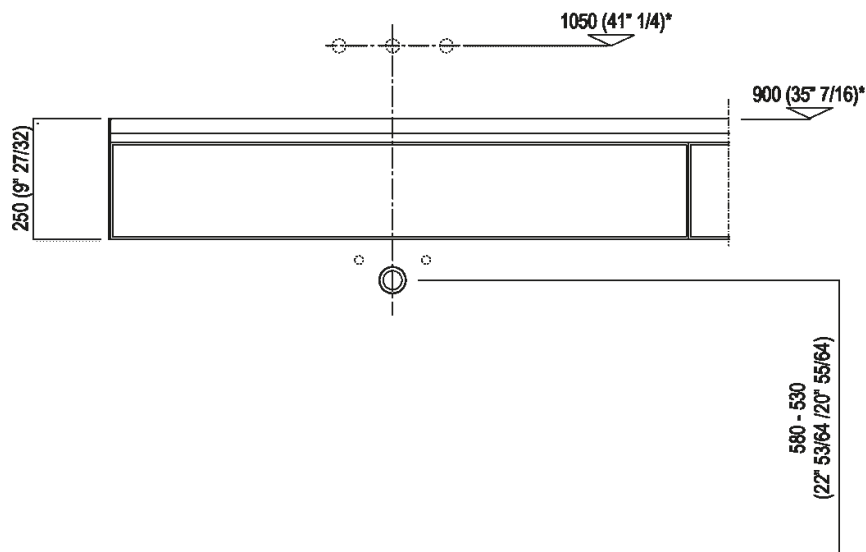

Scarico per sifone a bottiglia
Drain for bottle trap

*h.consigliata / advised h.



Quote di montaggio

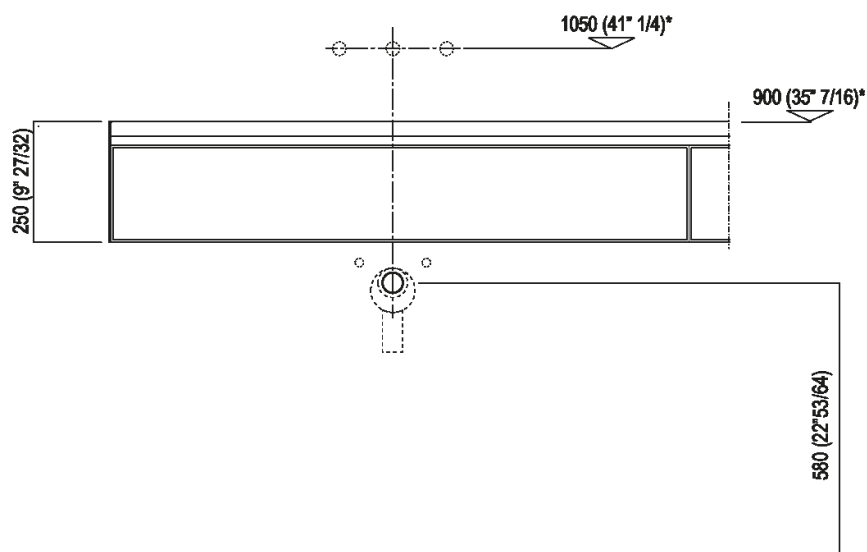

Scarico per sifone ad incasso
Drain for concealed waste trap
(.PLA456 + AKIT0731)











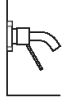
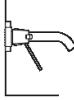

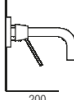
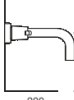

***h.consigliata / advised h.**

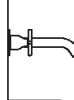

Posizionamento rubinetteria

POSIZIONE RUBINETTERIA / TAP POSITION

Altezza consigliata / Recommended height

FEZ2	 115 AFEZ001	 150 AFEZ011	 200 AFEZ002/ AFEZ012	
FEZ	 115 ARUB10012S - ARUB10012D	 200 ARUB020	 200 ARUB13020	 200 ARUB12020
MEMORY	 116 AMEM011	 150 AMEM021/ AMEM031/ AMEM033	 200 AMEM022/ AMEM032/ AMEM034	
		 190 ARUB1036, ARUB1037		
SEN	 150 ASEM010	 110 ASEM012RS		
SQUARE	 125 ARUB1023	 110 ARUB020	 200 ARUB1021	 165 ARUB020, ARUB021, ARUB1023, ARUB1023 L, C2
			 165 H 180 mm (7" 3/32)	



Abaco componibile frontale in corrispondenza del
lavabo è fisso, i laterali sono cassette.

