

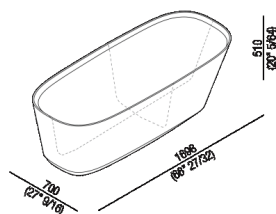

Bathtub
 AVAS1095_

Benedini Associati, 2018

Ultra-light and easy to install free-standing bathtub.



Bathtub in white Cristalplant® or two colourd (exterior in dark grey RAL7021 or light grey RAL7044); with overflow hole, without tap holes; taps can be wall or floor mounted. It is fitted with a waste with cap in white Cristalplant® .MET0725C (also suitable for bathtubs in display). The two-coloured model can be made in colours chosen by the client with a surcharge of 15% on the price of the two-coloured finish. For an easier installation of the bathtubs we recommend to use the template for the positioning of the waste trap AKITPZVAS.

Finiture

-  White/dark grey
-  White/light grey
-  White

Materiali

-  Cristalplant® biobased

Altezza:	51 cm	20" 5/64 inches
Lunghezza:	169.8 cm	66" 27/32 inches
Peso:	76 kg	168 lbs
Profondità :	70 cm	27" 9/16 inches
Capacità:	300 l	79 gal
Confezione:	100 x 200 x 82 cm	39" 3/8 x 78" 3/4 x 32" 1/4 inches
Peso della confezione:	168 kg	304 lbs



Main dimensions

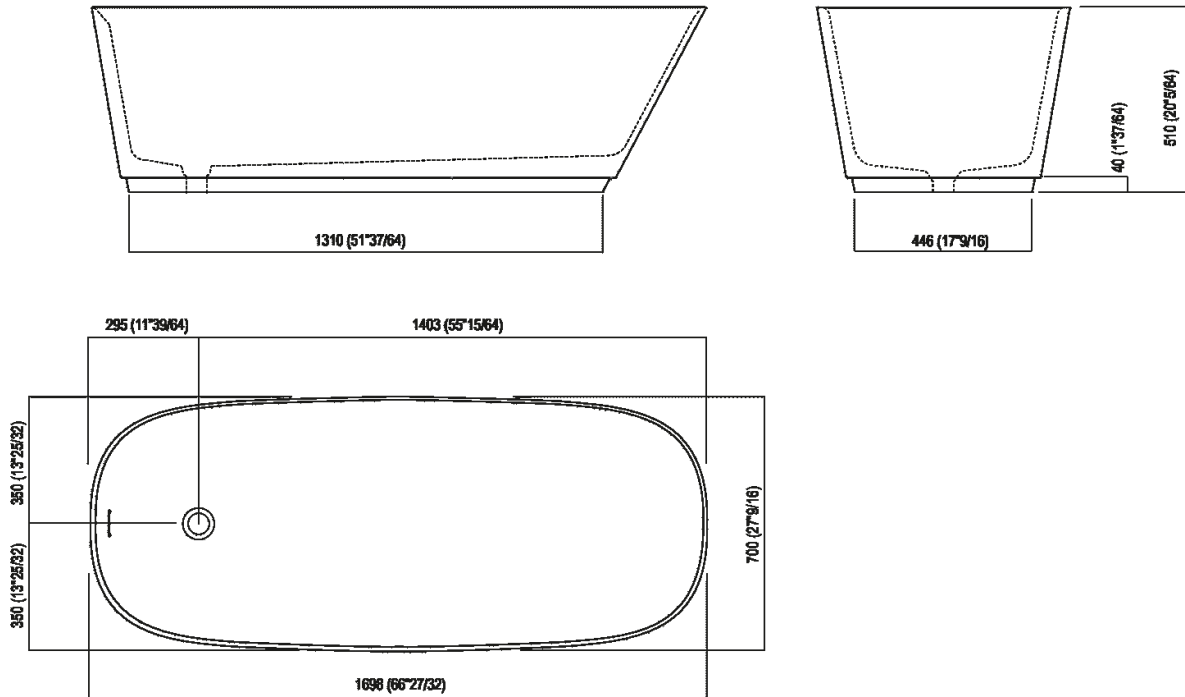



Dimensions for recess

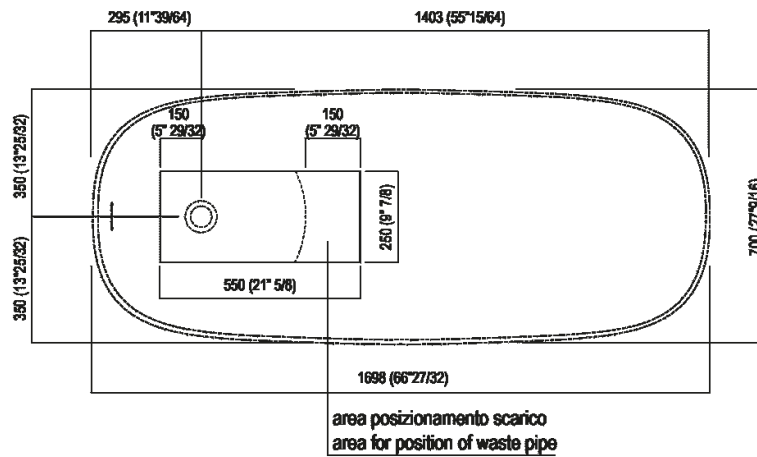



Installation notes: wall mounted tap

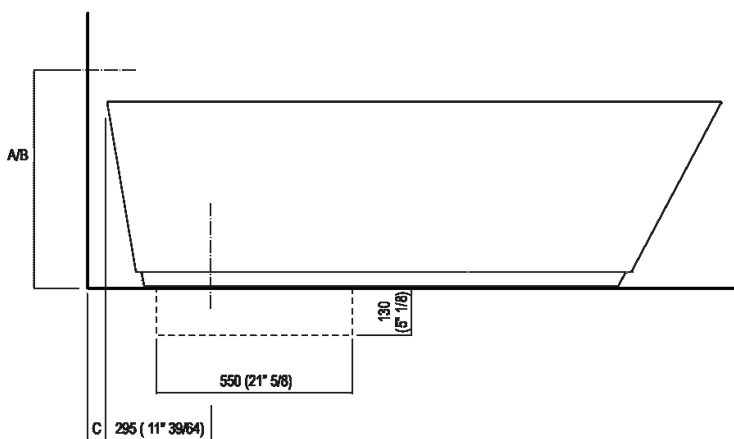
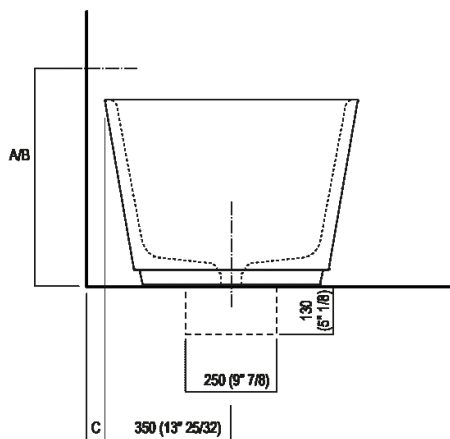

		A*	B**	C
FEZ	ARUB050000L, ARUB051000L, ARUB150000C, ARUB151000C, ARUB190000C, ARUB191000C,	660 (25° 63/64)	-	50 (1°31/32)
MEMORY	ARUB1076, ARUB1077, ARUB1040, ARUB1089, ARUB1091	660 (25° 63/64)		150 (5°29/32)
SQUARE	ARUB0932N, ARUB0933N, ARUB1117	-	640 (25° 13/64)	50 (1°31/32)
SQUARE	ARUB1118	660 (25° 63/64)	-	150 (5°29/32)
SEN	ASEN0912V	-	660 (25°63/64)	50 (1°31/32)

* interasse gruppo / axial distance for tap

** filo inferiore gruppo / Tap's lower edge



Installation notes: floor-mounted t

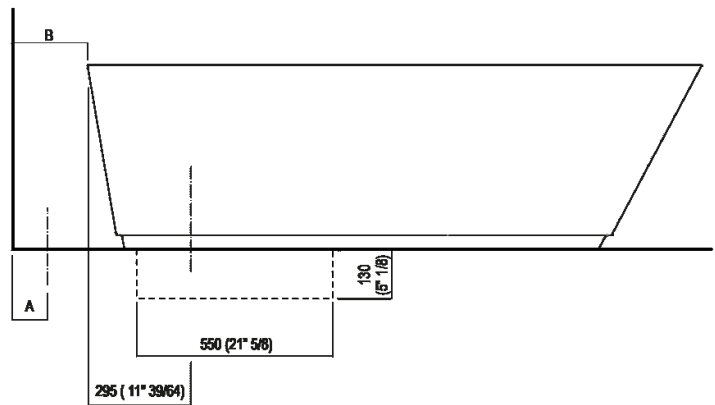
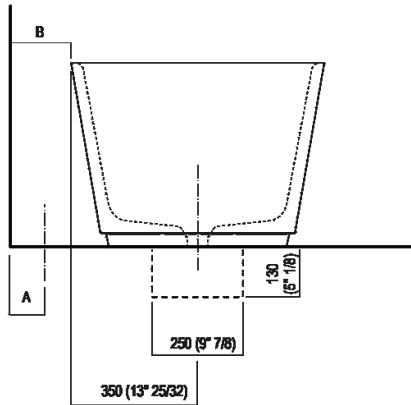

	A	B
SEN (ASEN0911,ASEN0977)	80 (3 ¹ / ₈)	130 (5 ¹ / ₈)
SQUARE (ARUB1112-ARUB1115)	80 (3 ¹ / ₈)	200 (7 ⁷ / ₈)
FEZ (ARUB140,ARUB141,ARUB145,ARUB147,ARUB170)	80 (3 ¹ / ₈)	165 (6 ¹ / ₂)
MEMORY (ARUB1033,ARUB1078)	80 (3 ¹ / ₈)	165 (6 ¹ / ₂)



Note

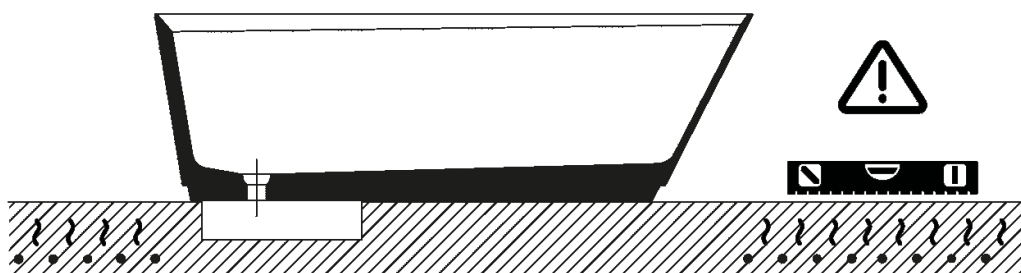

La vasca deve essere installata su un pavimento perfettamente piano.
The bathtub must be positioned on a flat floor surface.

E' necessario predisporre a pavimento un pozzetto.
It is necessary to prepare a recess in the floor.

Evitare di realizzare impianti di riscaldamento nell'area sottostante la vasca.
Avoid the installation of floor heating plants in the area under the bathtub.