

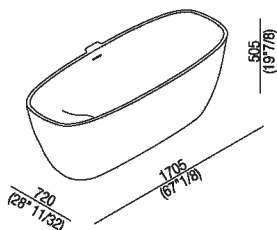

Vasca
 AVAS0910_

Benedini Associati, 2008

Vasca free-standing in Cristalplant®
 biobased di dimensioni contenute.



Vasca in Cristalplant® biobased bianco o bicolore (esterno grigio scuro RAL7021 o grigio chiaro RAL7044); con foro per troppo pieno, senza fori per rubinetteria; questa può essere collocata a parete o a terra. È obbligatorio l'utilizzo della piletta sifonata .MET0477 o .MET0477C (.MET0434 o .MET0477C per vasche in esposizione). La versione bicolore può essere realizzata con colore indicato dal cliente con maggiorazione del 15% sul costo della finitura bicolore. Per un'installazione più agevole, si suggerisce l'utilizzo del pozzetto per vasca AKITPZVAS.

Finiture



Bianco



Bianco/grigio scuro



Bianco/grigio chiaro

Materiali



Cristalplant® biobased

Altezza:	50.5 cm	19" 7/8 inches
Lunghezza:	170.5 cm	67" 1/8 inches
Peso:	76 kg	168 lbs
Profondità :	72 cm	28" 11/32 inches
Capacità:	273 l	72 gal
Confezione:	100 x 200 x 82 cm	39" 3/8 x 78" 3/4 x 32" 1/4 inches
Peso della confezione:	134 kg	295 lbs



Dimensioni principali

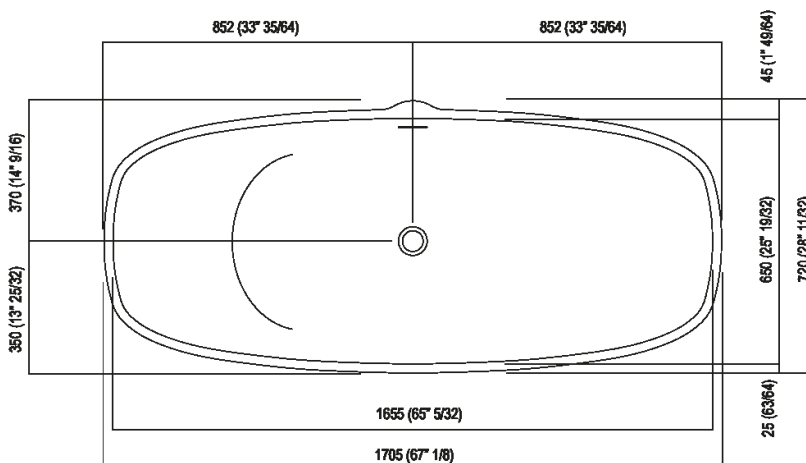
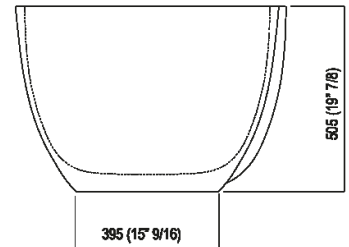
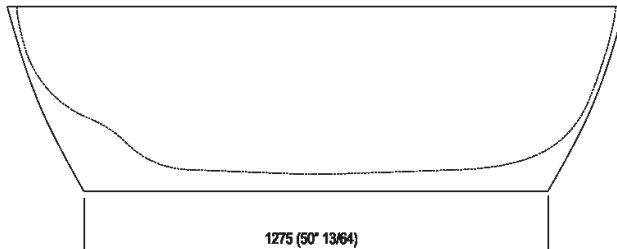



Quote per pozzetto

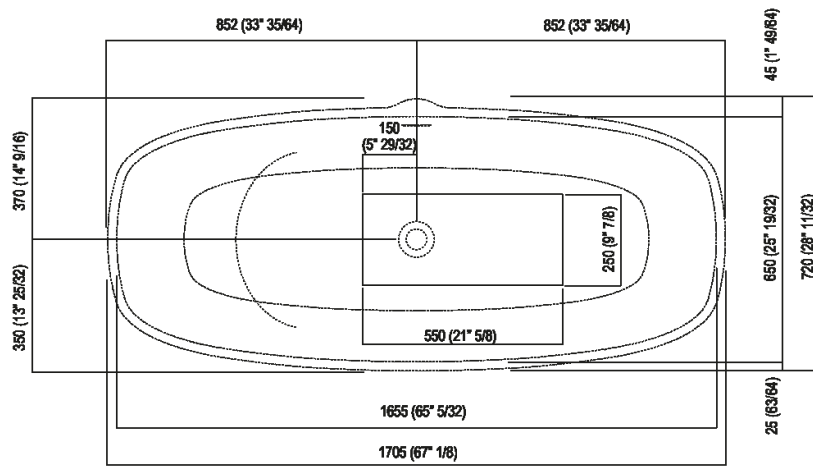



Quote per rubinetteria a parete

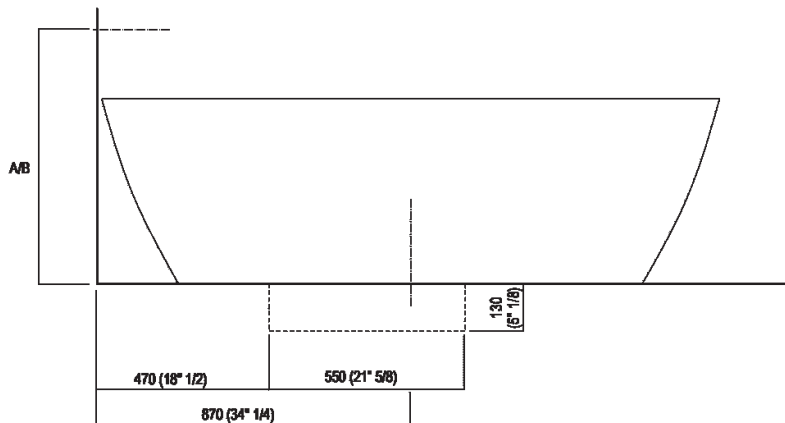
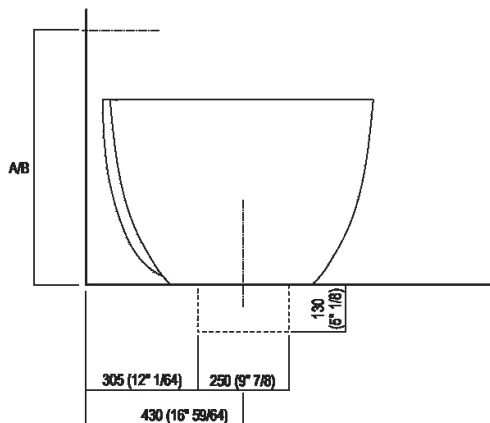

	A*	B**
FEZ (ARUB050000L, ARUB051000L, ARUB150000C, ARUB151000C, ARUB1089S, ARUB190000C, ARUB191000C, ARUB1091S)	700 (27' 1/2)	-
MEMORY (ARUB1076S, ARUB1077S, ARUB1040S)	700 (27' 1/2)	-
SUITE (ARUB1107S)	700 (27' 1/2)	-
SQUARE (ARUB0932N, ARUB0933N)	-	700 (27' 1/2)
SEN (ASEN0912V)	-	700 (27' 1/2)

* inserese gruppo / axial distance for tap
 ** filo inferiore gruppo / Tap's lower edge



Quote per piantane da terra

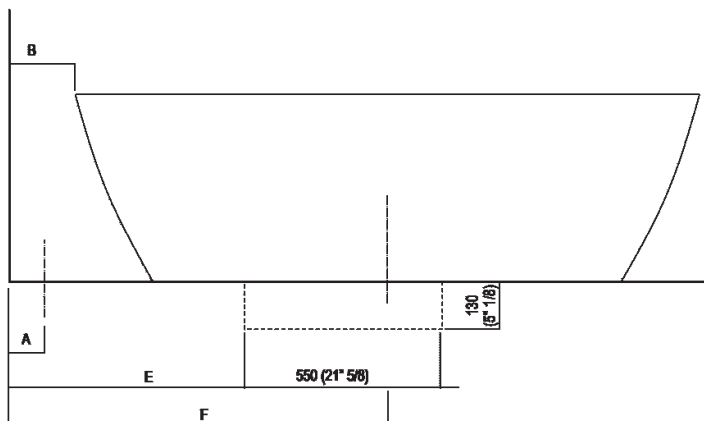
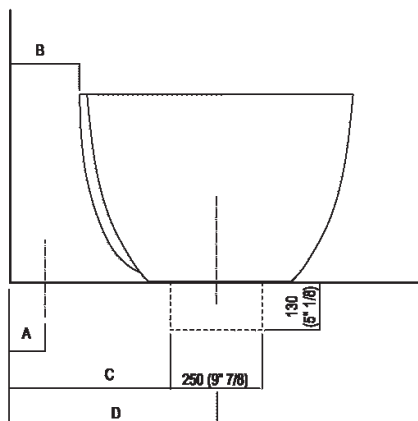

	A	B	C	D	E	F
FEZ (ARUB140, RAUB145, ARUB170N)	80 (3 ¹ / ₈)	180 (7 ³ / ₃₂)	435 (17 ¹ / ₈)	560 (22 ¹ / ₁₆)	630 (24 ¹³ / ₁₆)	1030 (40 ⁹ / ₁₆)
MEMORY (ARUB1078, ARUB1072, ARUB1033)	80 (3 ¹ / ₈)	180 (7 ³ / ₃₂)	435 (17 ¹ / ₈)	560 (22 ¹ / ₁₆)	630 (24 ¹³ / ₁₆)	1030 (40 ⁹ / ₁₆)
SQUARE (ARUB0961L, ARUB0934L, ARUB0935NL, ARUB0936NL, ARUB0952L, ARUB1024N)	80 (3 ¹ / ₈)	130 (5 ¹ / ₈)	385 (15 ⁵ / ₃₂)	50 (20 ⁵ / ₆₄)	580 (27 ²⁷ / ₃₂)	980 (38 ⁹ / ₁₆)
SUITE (ARUB1108S)	80 (3 ¹ / ₈)	180 (7 ³ / ₃₂)	435 (17 ¹ / ₈)	560 (22 ¹ / ₁₆)	630 (24 ¹³ / ₁₆)	1030 (40 ⁹ / ₁₆)
SEN (ASEN0911)	80 (3 ¹ / ₈)	130 (5 ¹ / ₈)	385 (15 ⁵ / ₃₂)	510 (20 ⁵ / ₆₄)	580 (27 ²⁷ / ₃₂)	980 (38 ⁹ / ₁₆)



Quote per colonna porta rubinetteria

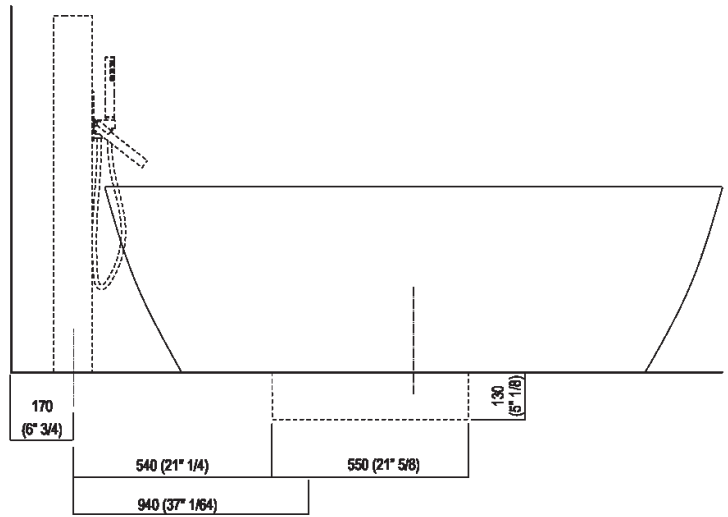
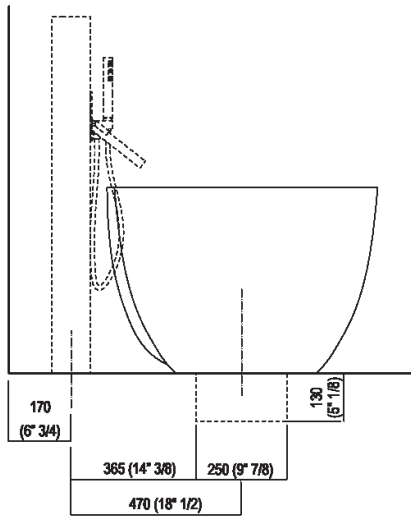



Nota

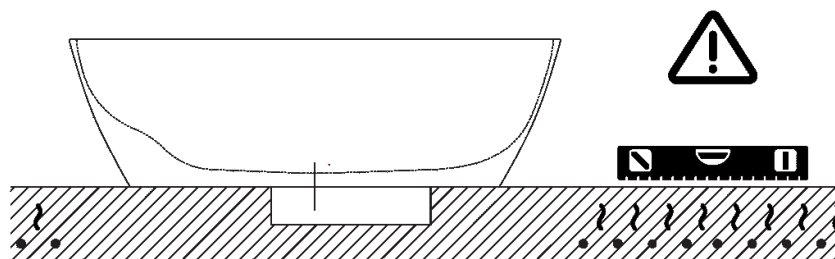

**La vasca deve essere installata su un pavimento perfettamente piano.
The bathtub must be positioned on a flat floor surface.**

**E' necessario predisporre a pavimento un pozzetto.
It is necessary to prepare a recess in the floor.**

**Evitare di realizzare impianti di riscaldamento nell'area sottostante la vasca.
Avoid the installation of floor heating plants in the area under the bathtub.**