

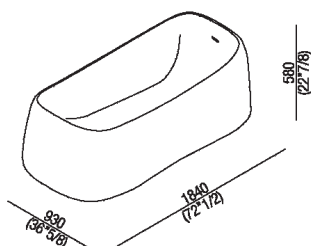

Vasca  
 AVAS0920Z

Patricia Urquiola, 2007

Vasca free-standing in Cristalplant®  
 biobased dalla forma ergonomica.



Vasca in Cristalplant® bianco con foro per troppo pieno, senza fori per rubinetteria; questa può essere collocata a parete o a terra. È obbligatorio l'utilizzo della piletta sifonata .MET0477 (.MET0434 per vasche in esposizione). Per un'installazione più agevole, si suggerisce l'utilizzo del pozzetto per vasca AKITPZVAS.

**Finiture**

Bianco

**Materiali**

Cristalplant®

Altezza:	58 cm	22" 7/8 inches
Lunghezza:	184 cm	72" 1/2 inches
Peso:	173 kg	381 lbs
Profondità :	93 cm	36" 5/8 inches
Capacità:	310 l	82 gal
Confezione:	106 x 197 x 70 cm	41" 6/8 x 77" 4/8 x 27" 4/8 inches
Peso della confezione:	200 kg	441 lbs



Dimensioni principali

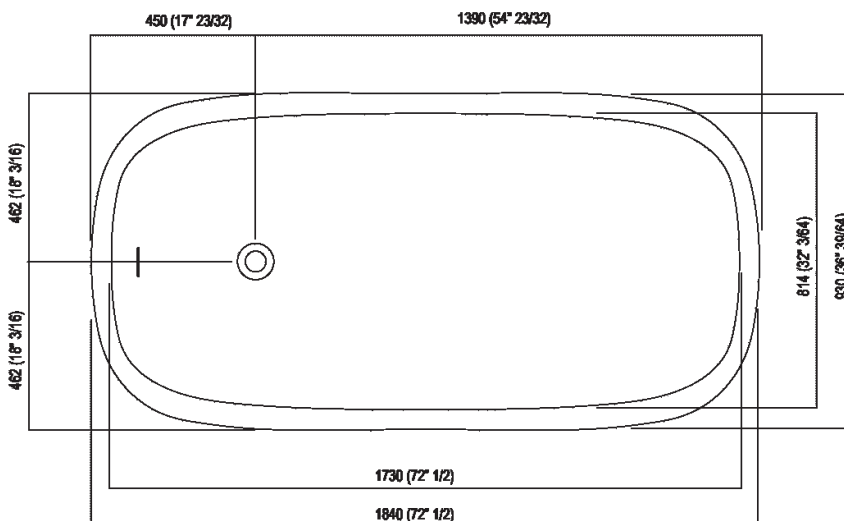
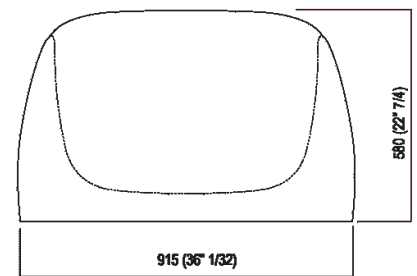
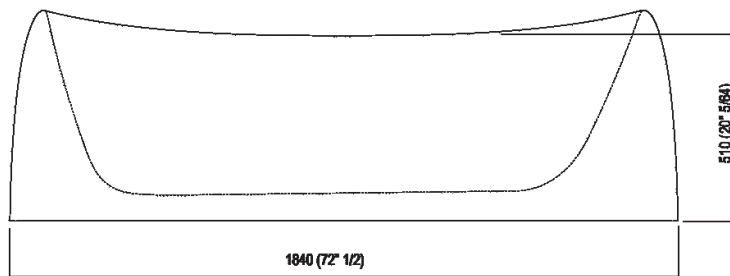



Quote per pozzetto

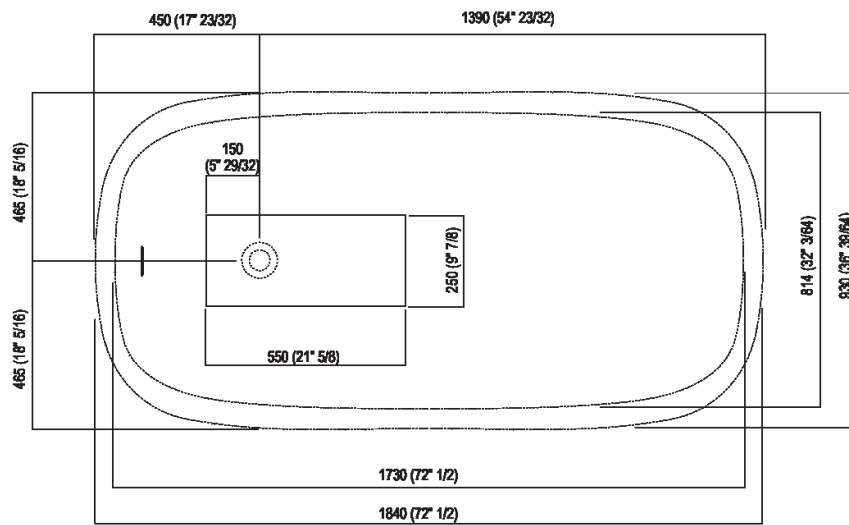



Quote per rubinetteria a parete

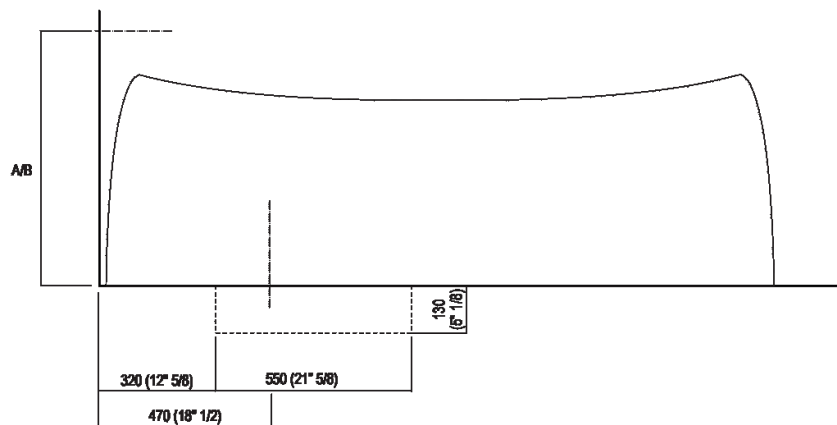
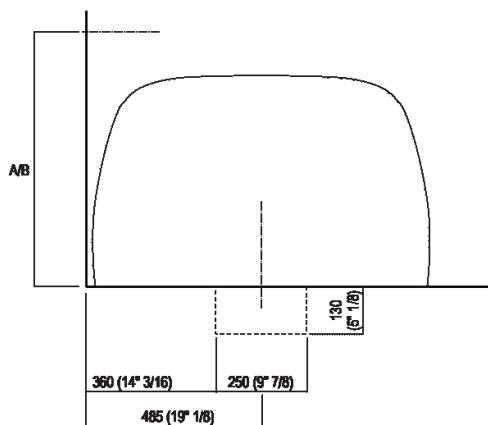

	A*	B**
FEZ (ARUB050000L, ARUB051000L, ARUB150000C, ARUB151000C, ARUB1089S, ARUB190000C, ARUB191000C, ARUB1091S)	660 (26")	-
MEMORY (ARUB1076S, ARUB1077S, ARUB1040S)	660 (26")	-
SUITE (ARUB1107S)	660 (26")	-
SQUARE (ARUB0932N, ARUB0933N)	-	690 (27 3/16)
SEN (ASEN0912V)	-	-

\* inserese gruppo / axial distance for tap  
\*\* filo inferiore gruppo / Tap's lower edge



Quote per piantane da terra

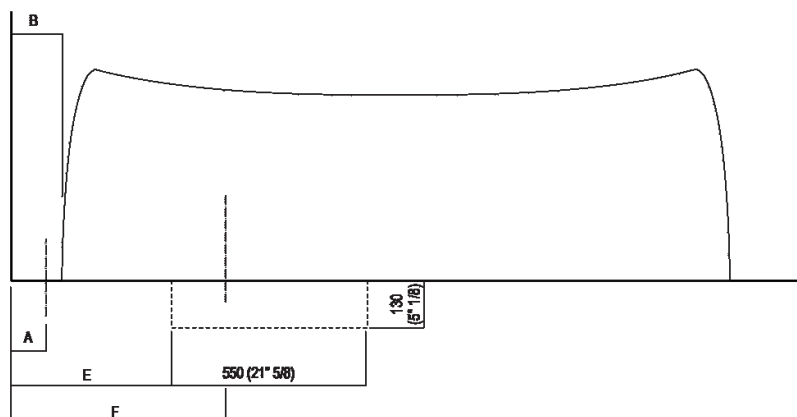
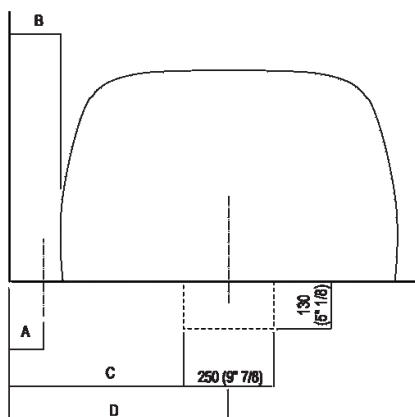

590 (23"15/64)	A	B	C	D	E	F
FEZ (ARUB140, RAUB145, ARUB170N)	80 (3"1/8)	140 (5"33/64)	480 (18"57/64)	605 (23"13/16)	440 (17"21/64)	590 (23"15/64)
MEMORY (ARUB1078, ARUB1072, ARUB1033)	80 (3"1/8)	140 (5"33/64)	480 (18"57/64)	605 (23"13/16)	440 (17"21/64)	590 (23"15/64)
SQUARE (ARUB0961L, ARUB0934L, ARUB0935NL, ARUB0936NL, ARUB0952L, ARUB1024N)	80 (3"1/8)	140 (5"33/64)	480 (18"57/64)	605 (23"13/16)	440 (17"21/64)	590 (23"15/64)
SUITE (ARUB1108S)	80 (3"1/8)	140 (5"33/64)	480 (18"57/64)	605 (23"13/16)	440 (17"21/64)	590 (23"15/64)
SEN (ASEN0911)	-	-	-	-	-	-



**Quote per colonna porta rubinetteria**

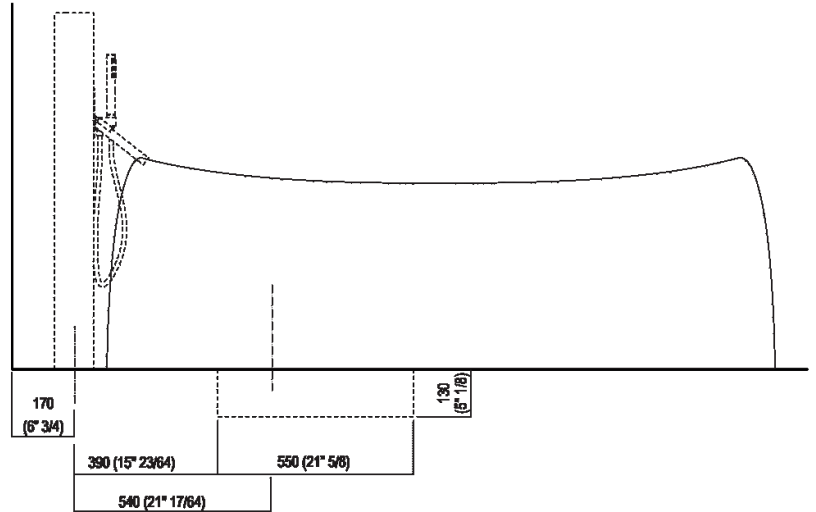
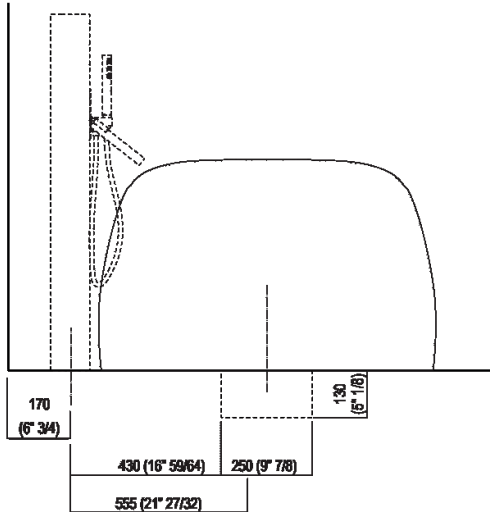



Nota

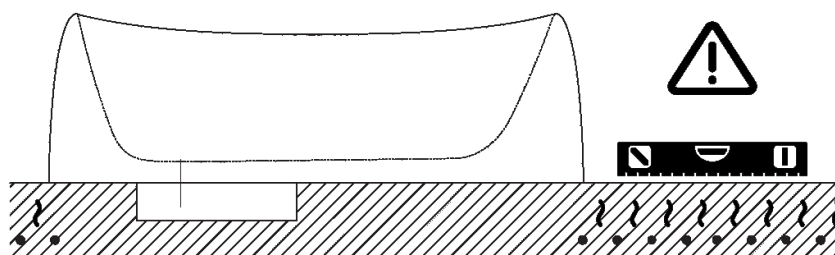

**La vasca deve essere installata su un pavimento perfettamente piano.  
The bathtub must be positioned on a flat floor surface.**

**E' necessario predisporre a pavimento un pozzetto.  
It is necessary to prepare a recess in the floor.**

**Evitare di realizzare impianti di riscaldamento nell'area sottostante la vasca.  
Avoid the installation of floor heating plants in the area under the bathtub.**